

DENSO

Member of the TOYOTA Group

HANDHELD TERMINAL

BHT-1800

SERIES



Scanning on
a grand scale.



A touchscreen computer that pushes the boundaries: the BHT-1800 with 5" superscreen.

The BHT-1800 is the embodiment of a vision: to develop a touchscreen computer with a display that pushes the boundaries. The 5" superscreen means it packs DENSO's biggest ever display. As a result, the BHT-1800 offers even more space for state-of-the-art, high-volume scanning using smart mobile Android applications. The usability: child's play. The technology: high-performance. The quality: strictly DENSO. **Our new superlative.**



Original size

BIGGER:

5" superscreen – our new dimension in touchscreen computing.



MORE ERGONOMIC:

Angled scan head for a natural hand position, with the display always in view.



FASTER:

Thanks to side-mounted, individually configurable quick access magic keys and thumb-controllable virtual scan key.



TOUGHER:

Display with crack-resistant Asahi Dragontrail™ Pro glass fitted as standard – one of the best in the industry.



MORE UP-TO-DATE:

Running Android 7.1.2 (Nougat).

Made for the big challenges: the application areas.

The BHT-1800 demonstrates its capabilities especially where data has to be collected and processed in bulk. Its ergonomic concept, optimum view of the display and easy-to-use functions are perfect for speeding up reading processes.

Its great robustness makes the BHT-1800 ideal for countless indoor and outdoor applications.

These are just a few examples of its wide range of applications.

ORGANIZE LOGISTICS

Scan and locate your deliveries in real time using 4G LTE* and A-GPS – for tracking and tracing and improved route planning.



OPTIMISE FIELD SERVICE

Record the process status and progress immediately on site and communicate with head office whenever you need to – via wireless LAN and 4G LTE*.



PROFESSIONALISE RETAIL

Whether it's for warehousing, ordering or sales management, collect data with precision – even if codes are damaged.



* depending on model

Moving to the next dimension: the technical highlights.

Wherever better performance is demanded, technology has to progress.
The BHT-1800 makes advanced automatic ID technology the standard.



Reads 1D and 2D codes and NFC cards*
from 30 mm – even if they're damaged.
OCR is also supported.



Full connectivity
wireless LAN, 4G LTE and VoLTE, USB 2.0, Bluetooth 4.1 EDR/LE*



Supports Google Mobile Services.



3 YEAR warranty

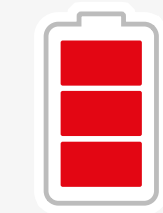

Battery life
perfect for long working hours.



Works at extreme temperatures from **-20° to +50° Celsius.**

2.50 metres
Survived umpteen fall tests from a height of up to 2.5 m.

Separate CPU
for non-stop scanning even when the central processor is running at full capacity.

App blocker
allows access to enterprise-relevant applications only.

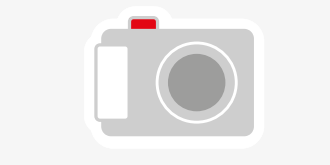

8 MP rear camera with autofocus
e.g. for documenting damaged deliveries.

Touchscreen easy to use
with wet fingers, gloves or a pen.

Ultra-lightweight:
only 275 g thanks to its polycarbonate housing.



IP67-certified
protection against water and dust.



GPS (A-GPS/GLONASS)
for faster localization and tracking.



Smarter communication
on the phone, online, using apps, sending text messages, taking photos and much more.

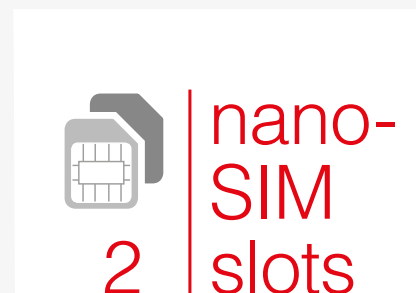

2 nano-SIM slots
one card for data communication, one for telephoning.

MADE TO MEASURE FOR YOUR REQUIREMENTS.

Choose from six models.

The more you expect of the BHT-1800 touchscreen computer, the wider its performance capabilities become. Even the entry-level version offers you all the key functions: Asahi Dragon-trail™ Pro glass and magic keys as standard. For those with even more sophisticated requirements, there's the high-end model packing the complete set of functions, from NFC to front camera.

Type	1D	2D	LTE	Camera rear	Camera front	NFC	W/L charge
BHT-1800QWBG-1-A7 (Standard)	✓	✓	✓	✓			
BHT-1800QWBG-2-A7 (Optional)	✓	✓	✓	✓	✓		
BHT-1800QWBG-3-A7 (Optional)	✓	✓	✓	✓	✓	✓	✓
BHT-1800QWB-1-A7 (Standard)	✓	✓		✓			
BHT-1800QWB-2-A7 (Optional)	✓	✓		✓	✓		
BHT-1800QWB-3-A7 (Optional)	✓	✓		✓	✓	✓	✓

* depending on model

BHT-1800 SERIES

Type	BHT-1800 QWBG-1-A7	BHT-1800 QWBG-2-A7	BHT-1800 QWBG-3-A7	BHT-1800 QWB-1-A7	BHT-1800 QWB-2-A7	BHT-1800 QWB-3-A7
OS	Android 7.1.2 (Nougat)					
CPU	1.3 GHz Quad-core					
Memory	RAM	2 GB				
	Flash ROM	16 GB				
Display	Number of dots ^{*1}	5.0 inch HD (1280x720 pixels)				
	Display system	Liquid crystal dot matrix display (colour)				
	Backlight	White LED				
Scanner	Reading system	Area sensor				
	Readable codes	2D Codes	QR Code, MicroQR Code, SQRC®, PDF417, MicroPDF417, MaxiCode, DataMatrix (ECC200), GS1 Composite			
		1D Codes	EAN-13/8(JAN-13/8), UPC-A/E, UPC/EAN (with add-on), Interleaved 2 of 5 (ITF), Standard 2 of 5 (STF), CODABAR (NW-7), CODE39, CODE93, CODE128, GS1-128 (EAN-128), GS1 DataBar (RSS)			
	Minimum resolution	2D Codes	0.167 mm			
		1D Codes	0.125 mm			
	Scanning reference position	100 mm				
	Marker	Area guide marker				
Scan confirmation	Visual (green LED), acoustic (speaker), haptic (vibration)					
Keypad	Number of keys	5 keys (incl. power key) + 2 trigger keys				
Touch panel	Asahi Dragontrail™ Pro - wet touch / gloved fingertip / stylus					
GPS	A-GPS/GLONASS					
Communication	Wireless LAN ^{*2}	Compatible standards	IEEE802.11a/b/g/n compliant			
		Frequency band	IEEE802.11a/n: 5.2 GHz, 5.3 GHz, 5.6 GHz band, IEEE802.11b/g/n: 2.4 GHz band			
		Transmission distance ^{*3}	IEEE802.11a: indoors = approx. 50m, IEEE802.11b/g/n: indoors = approx. 75m, outdoors = approx.200m			
		Transmission speed ^{*3}	IEEE802.11b: 11/5.5/2/1 Mbps, IEEE802.11a/g: 54/48/36/24/18/12/9/6 Mbps, IEEE802.11n: 65/58.5/52/39/26/19.5/13/6.5 Mbps			
		Access method	Infrastructure mode			
	Security	Encryption: WEP(40/128)/TKIP/AES, WPA authentication: WPA/WPA2, User authentication: PSK/EAP-TLS/PEAP				
WWAN	Compatible standards	4G LTE / 3G / GSM, VoLTE		-		
Bluetooth®	V4.1+EDR/LE (Compatible Profile: GAP/SDAP/HSP/SPP/GOEP/OPP/HFP(AG1.5)/PAN/A2DP/AVRCP/GAVDP/HID/PBAP/HOGP/MAP/GATT)					
USB (DNWA Connector)	USB 2.0					
Card slot	Micro SDHC and SDXC, microSIM x2					
Power supply	Power	Lithium-ion battery (2900 mAh)				
	Operating time ^{*4}	12 hours ^{*5}		24 hours ^{*6}		
NFC	-	yes	-	yes	-	yes
Wireless charging	-	yes	-	yes	-	yes
Camera	Rear	8 MP Autofocus				
	Front	-	5 MP	-	5 MP	-
Environmental requirements	Operating temperature ^{*7}	-20° to 50° C				
	Protection rating	IP67				
	Drop resistance ^{*8}	1.5 m x 180 times, 2.5 m				
Weight (incl. battery)	Approx. 275 g					

*1: Although the effective number of picture elements is more than 99.99% thanks to high-precision technologies used to manufacture LCDs, allow the possibility of some elements, less than 0.01%, that are missing or permanently turned on. *2: IEEE802.11a:5.2 GHz (W52) and 5.3 GHz (W53) are for indoor use only. *3: The communication distance and transmission speed shown are reference values, and may vary depending on the actual environmental conditions. *4: The described operating time is a reference figure under regular temperatures and may vary depending on usage conditions. *5: Scanning: scan update: standby = 1:30:270. Data is transmitted via wireless WAN during scan display. *6: Scanning: wireless communication: screen update: standby = 1:5:1:60. The vibrator and buzzer are disabled. The wireless function is always enabled, and all other functions are disabled. *7: Zero to 40° C when batteries are being recharged. *8: Result obtained in a test under regular temperature is shown and not meant as a guarantee.

COMPONENTS

- Main unit
- Lithium-ion battery BT-180LA with battery cover
- Hand strap
- Operator's guide

SOFTWARE

Software (pre-installed)

- Scanner configuration tool [Scanner Setting]
- Software trigger key [Touch Trigger]
- Application management tool [Application Launcher]
- HTML5 capable custom browser [Android Browser for BHT-1800]
- BHT setting tool [BhtShell]
- Wi-Fi setting and site survey [WlanManager]
- Device management software [BHT-DMS Client]*
- OCR scanning software [OCR reader]*
- QR Code/SQRC® scanning app [QR Code reader Q installer]

*Software available with payment of a fee. A license fee is separately charged for its use.

Development Tool

- Software Development Kit for Android (SDK) dedicated for the BHT-1800 series.

DIMENSIONS

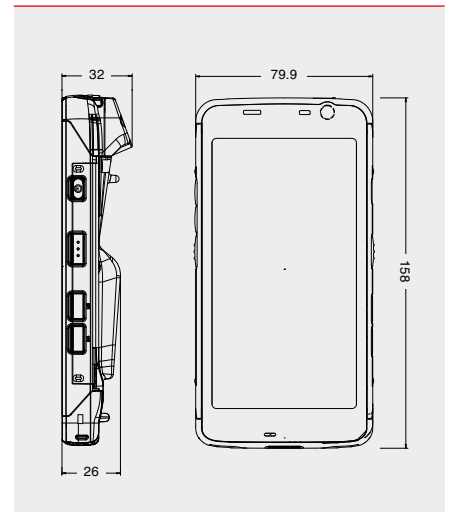

ACCESSORIES (separately sold)

Communication / Charger

- CU-BU1-18 (USB cradle incl. 1 slot unit/ battery charger)
- CU-BL1-18 (LAN cradle incl. 1 slot unit/ battery charger)
- CH-B4-18 (4-slot unit charger)
- CH-1804 (4-slot battery charger)

- CBBHT-US2000/C18-4A (USB direct cable)

Batteries

- BT-180LA (standard)

Others

- PNBHT-1700 (stylus pen)
- HBBHT-1800 (hand belt)

Items with this mark are available from the DENSO WAVE website (QBdirect) free of charge.

DENSO

TT Network Integration Europe GmbH
DENSO Auto-ID Business Unit

Immermannstr. 65 B
D-40210 Düsseldorf

+49 211 54 55 47 450

info@denso-autoid-eu.com

For more information, please visit our website
www.denso-autoid-eu.com



TO USE THIS PRODUCT SAFELY

Before using this product, read its User's Manual thoroughly.

QR Code is a registered trademark of DENSO WAVE INCORPORATED. Product appearance and specifications are subject to change without notice. © 2018 DENSO Auto-ID Business Unit of TTNI-E